

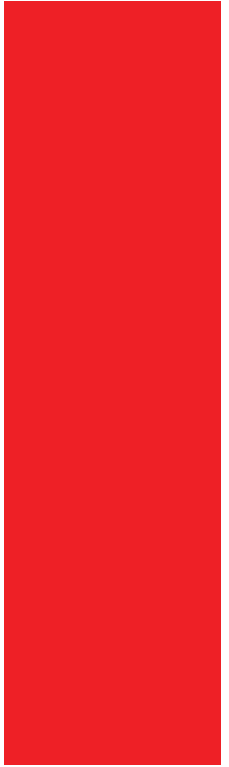

CROWDED SPACES SOLUTIONS

 **Ezi Security Systems**
SERIOUS SECURITY IS EZI







SAFER PUBLIC SPACES.

OUR PHILOSOPHY

Ezi Security Systems designs, manufactures and installs a premium range of perimeter security solutions for both vehicle and pedestrian access control, with specialised expertise in Hostile Vehicle Mitigation and protection of Crowded Spaces. With core competence established over 23 years, Ezi Security Systems provides innovations of our own invention, and via alliances with undisputed world leaders in our field, deliver sophisticated solutions at the leading edge of global technology.

Over the past 5 years the world has changed dramatically. In collaboration with our strategic business partners, Ezi has responded with focus, mitigating hostile vehicle threats with our Crowded Spaces range of products. Ezi offers permanent solutions for risk categories from low to extreme, as well as rapid deployment products for crowded spaces and public events, such as the Impakt and Rapid Defender products.

All Ezi Security Systems AVB and HVB systems have been rigorously crash tested and certified to meet requisite ASTM, IWA and PAS 68 stipulations. Along with our global partners, Ezi Security Systems actively collaborate in the development and deployment of contemporary strategies such as VAAW (Vehicle as a Weapon) mitigation, deploying whole of environment solutions. Ezi have solutions to meet your very highest security requirements whilst maintaining an aesthetically compatible solution for your site.

You can be confident that when serious security is your requirement, you need look no further than Ezi. We stand ready to be of expert service in an ever evolving environment, as global security risks increasingly demand local solutions.



CONTENTS

THE PAGE OF CONTENTS



01 **PRODUCT RANGE** **PAGE 06**

02 **ENGINEERED SOLUTIONS** **PAGE 08**

03 **CUBE AND BENCH BLOCKS** **PAGE 10**

04 **SPHERICAL BOLLARD & PLANTERS** **PAGE 12**

05 **SWATCH AND MOUNTING OPTIONS** **PAGE 14**

06 **PAS 68 TESTED AND CERTIFIED** **PAGE 16**

07 **BESPOKE SOLUTIONS** **PAGE 18**

08 **CRASH RATED PLANTERS** **PAGE 20**

09 **CRASH RATED SEATING OPTION** **PAGE 22**

10 **CRASH BLOCKS** **PAGE 23**

11 **RAPID DEPLOYABLE UNFIXED SOLUTIONS** **PAGE 24**

ENGINEERED SOLUTIONS



PAS 68 CRASH CERTIFIED



PRODUCT RANGE

ENGINEERED SOLUTIONS



PROTECTIVE PASSIVE BARRIERS are options best to fulfill aesthetic requirements of the crowded spaces while providing additional layer of protection among the public.

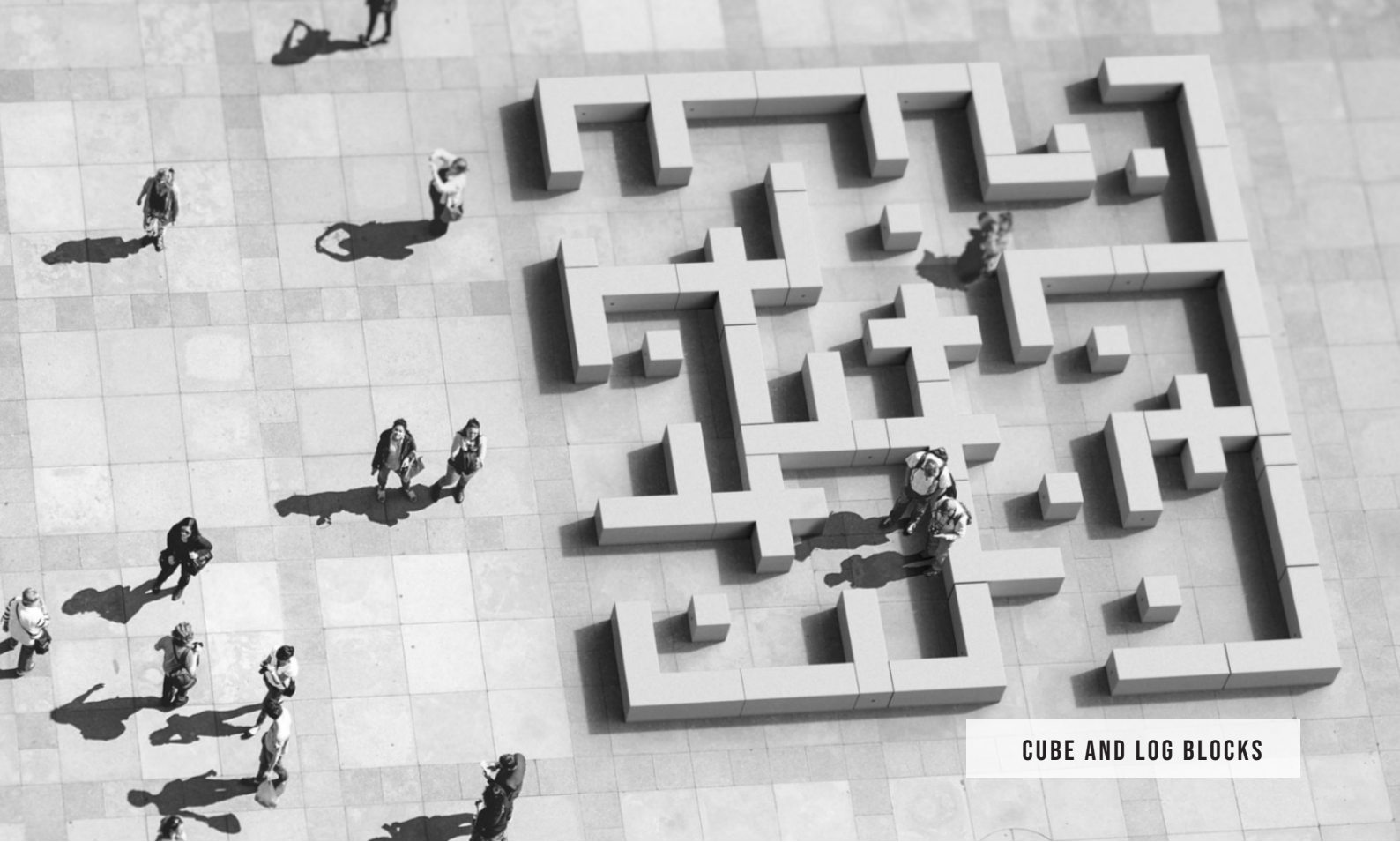

CUBE AND LOG BLOCKS



TALL PLANTER BOX



PLANTERS



TIMBER SLAT BENCH



SPHERICAL BLOCK

CUBE AND BENCH BLOCKS

PASSIVE BARRIERS ENGINEERED SOLUTIONS



Drilled bolt threads for lifting

*Product design and dimension are not fixed and can be modified according to client's preference.



DESCRIPTION

Ezi Security Cube and Log blocks modular system are contemporary and flexible range of passive barriers which comprises a number of different seating options, giving the flexibility to vary colour, texture and with almost unlimited configurations.

These passive barriers can be engineered as free standing, rooted ground fixed and base plate fixed for more

robust construction. The cube and logs can be modified and combined in a variety of configurations to suit any environment. Non-water absorbent and frost resistant aggregates are available to ensure that the product will not alter over time and prevent mould formation.

A drilled eyebolt threads can be embedded for easy lifting and handling.

MATERIALS: Pre-Cast
Granite
Precious Stone

FINISH: Anti-Graffiti Coating;
Nanotechnology Coating;
Manufacturer's coating

COLOURS Pre-Cast Grey;
Pre-Cast White;
Pre-Cast Charcoal

White Granite
Off White Granite

Red Verona
Multi Veneziano
Yellow Mori
Black Ebony
Cream Bottoccino
Green Alps
Brown Porphyry

Pattern and logo can be added to the finished product

See page 14 for color swatches, materials and mounting options

- ✓ Dual purpose and seating option
- ✓ Choose from variety of colors
- ✓ Combine with other elements



*Product design and dimension are not fixed and can be modified according to client's preference.



SPHERICAL BOLLARDS & NON-RATED PLANT

PASSIVE BARRIERS ENGINEERED SOLUTIONS

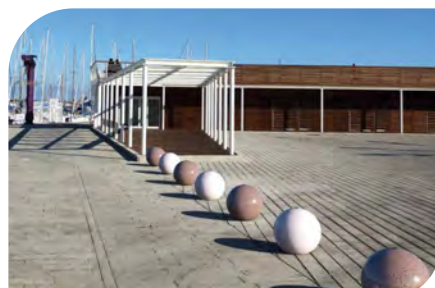
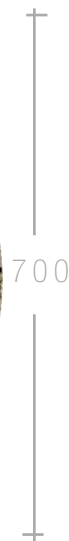

*Product design and dimension are not fixed and can be modified according to client's preference.



DESCRIPTION

Spherical Bollard are designed to provide robust and effective demarcation of pedestrian areas, while providing a complementary look and feel to public spaces.

The Spherical 700 Bollard is manufactured from high-quality concrete for added strength and durability to increase protection. Sitting on top of a 100mm plinth, The

bollard measures 700mm in diameter and can be supplied in a selection of colours alongside the standard exposed silver grey.

The bollard can be provided in either a smooth, exposed or etched finish. Additional finish options include personalised sand etching, which allows custom designs to be etched into the bollard's surface, on smooth finishes only.

MATERIALS: Pre- Cast
Granite
Precious Stone

FINISH: Anti-Graffiti Coating;
Nanotechnology Coating;
Manufacturer's coating

Pattern and logo can be added to the finished product

COLOURS Pre- Cast Grey;
Pre- Cast White;
Pre- Cast Charcoal

White Granite
Off White Granite

Red Verona
Multi Veneziano
Yellow Mori
Black Ebony
Cream Bottoccino
Green Alps
Brown Porphyry

See page 14 for color swatches, materials and mounting options

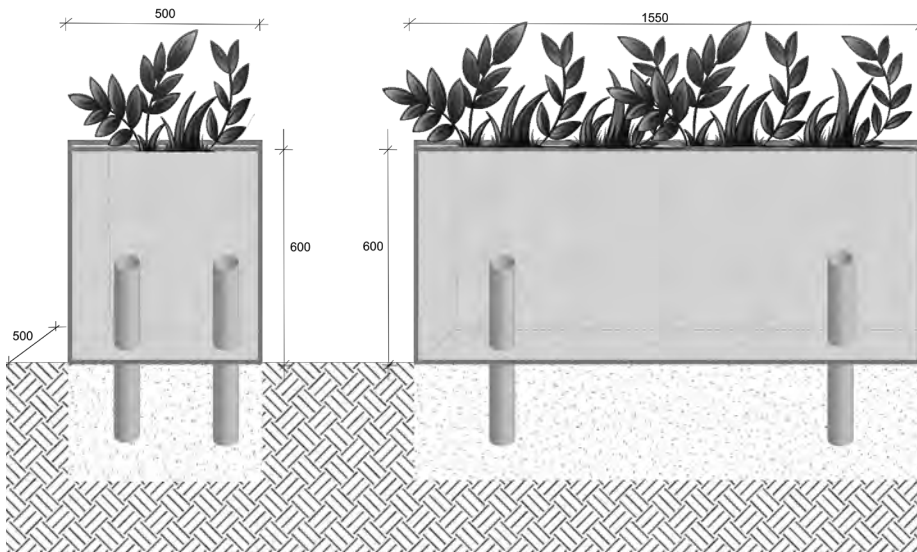

*Product design and dimension are not fixed and can be modified according to client's preference.



DESCRIPTION

The Ezi planters are passive security barriers providing balance between security measure and functionality of a public space advocating for green environment. These planters is fitted with a water reserve system which maintains the soil at a proper level of humidity without internal dispersion of water.

A self-levelling system ensures that the planter is levelled on slopes with up to a 6% incline.

Ezi planters dimension can be modified to fit our PAS 68 Truckstopper range of products.

MATERIALS: Pre- Cast
Granite
Precious Stone

FINISH: Anti-Graffiti Coating;
Nanotechnology Coating;
Manufacturer's coating

Pattern and logo can be added to the finished product

COLOURS Pre-Cast Grey;
Pre-Cast White;
Pre-Cast Charcoal

White Granite
Off White Granite

Red Verona
Multi Veneziano
Yellow Mori
Black Ebony
Cream Bottoccino
Green Alps
Brown Porphyry

See page 14 for color swatches, materials and mounting options

COLOUR & MATERIAL SPECIFICATIONS

PRE-CAST OPTIONS

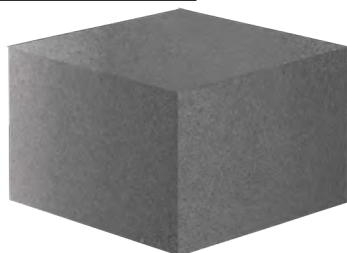

PRE-CAST CHARCOAL



PRE-CAST WHITE



PRE-CAST GREY

GRANITE & PRECIOUS STONE OPTIONS

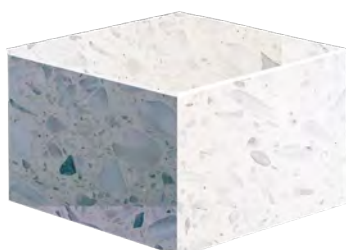

HYAMS WHITE
(G)



WHITSUNDAYS OFF WHITE
(G)

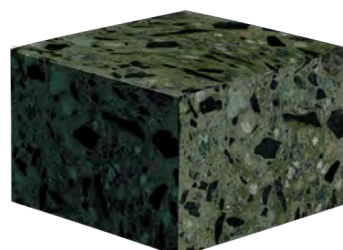

PERISHER GREEN ALPS
(PS)



CAIRNS BOTTICINO
(PS)

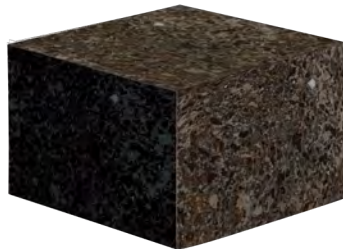

QUEENSLAND PORPHYRY
(PS)



SOUTH AUSTRALIAN BLACK EBONY
(PS)

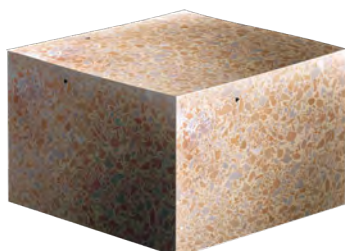

WESTERN SYDNEY YELLOW MORI
(PS)

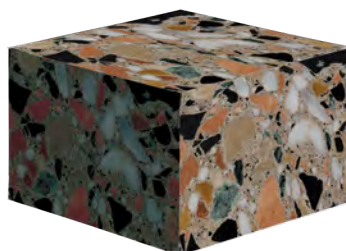

MELBOURNE VENEZIANO
(PS)



SYDNEY RED VERONA
(PS)

MOUNTING OPTIONS



FREE STANDING

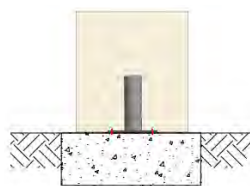

SURFACE FIXED



BASE PLATE FIXED



ROOTFIXED



CREATING GREAT AND
SECURE OUTDOORS



PAS68 TESTED & CERTIFIED



GLOVE PLANTER AND IGNEO SEAT



EOS SEAT



CRASH RATED PLANTERS



STREET INFO FRAMES

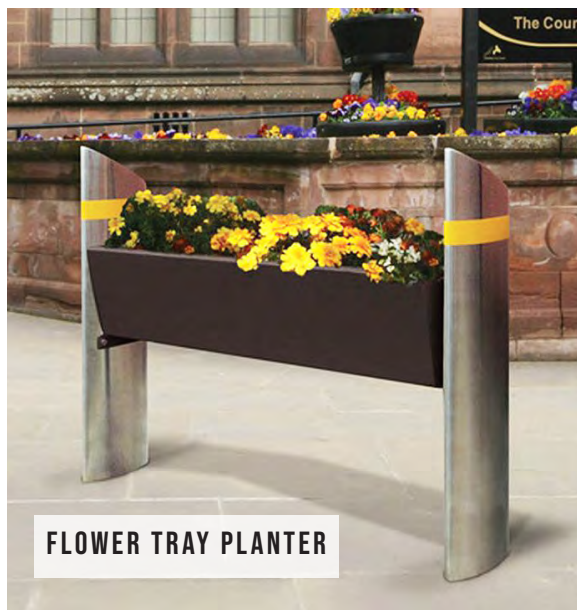

FLOWER TRAY PLANTER

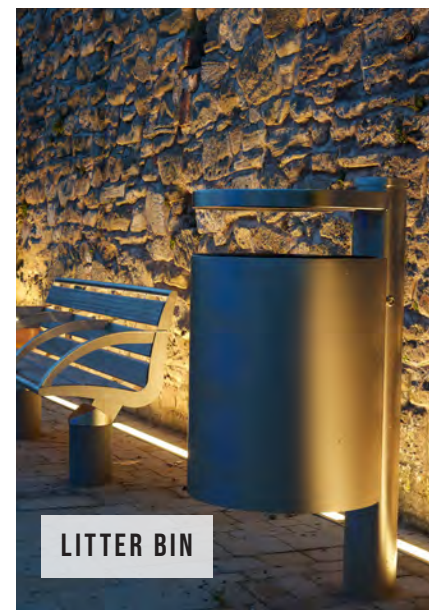

LITTER BIN

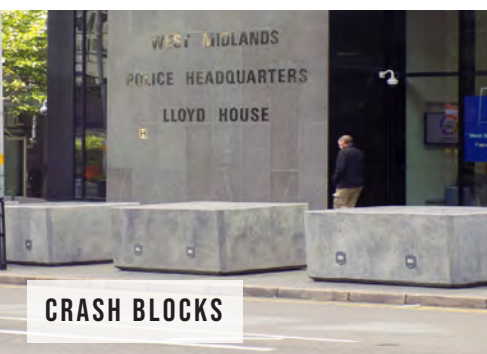

CRASH BLOCKS



BALUSTRADE



BIKE RACK



RAPID DEFENDER



IMPAKT DEFENDER

BESPOKE SECURITY SOLUTIONS

SAFETY BALUSTRADE, BIKE RAILS & SIGN FRAMES

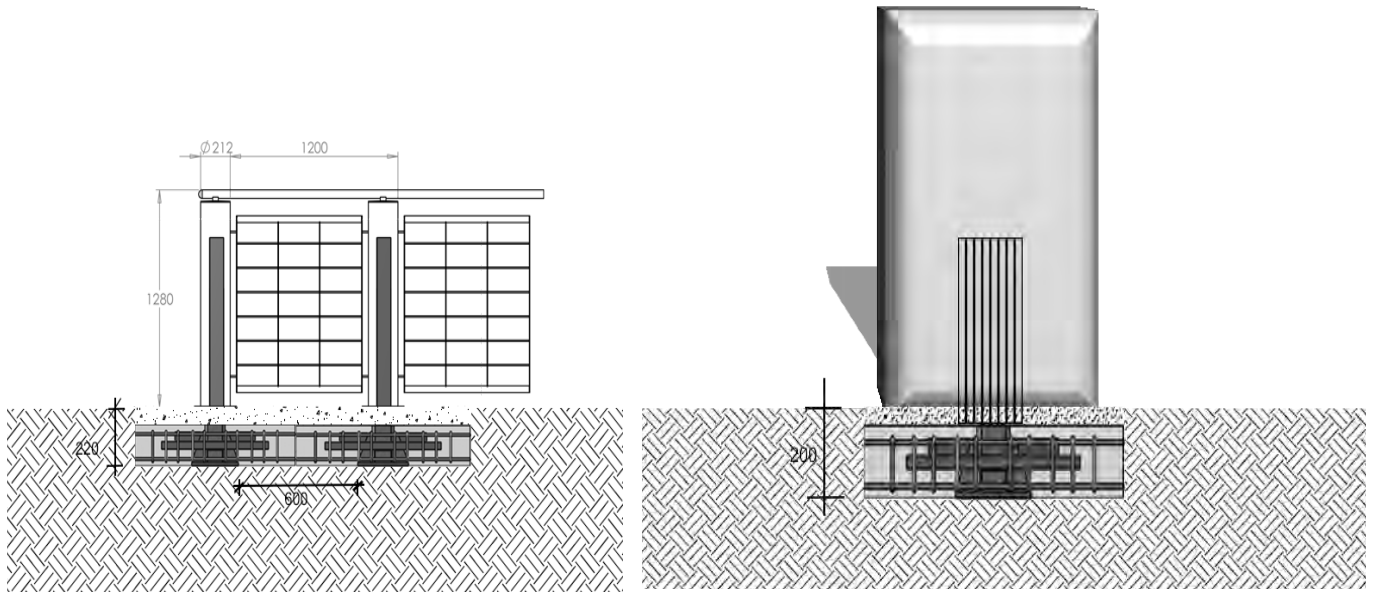

*Product design and dimension are not fixed and can be modified according to client's preference.

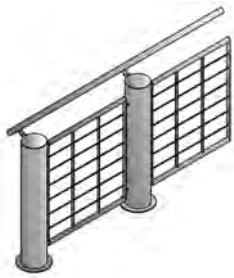

BALUSTRADE

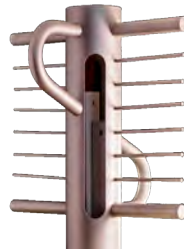

BIKE RACKS WITH HANRAILS



STREET SIGN FRAMES



safety BALUSTRADE



truckstopper 7 with handrail



bespoke sign frames



SEAT AND LITTER BINS

- ✓ Made from high grade stainless steel,
- ✓ The PAS 68 Spring Technology within these shrouds guarantees a high standard perimeter protection
- ✓ Real camouflaged security without compromising site design and architecture
- ✓ Contemporary and timeless



**Product design and dimension are not fixed and can be modified according to client's preference.*

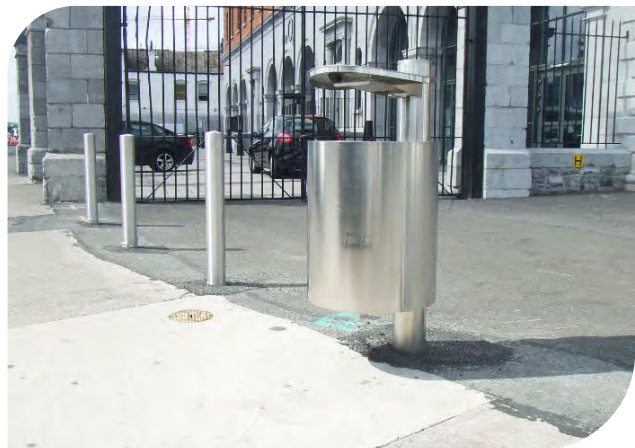

Ezi provides a flexible range of bespoke solution using Safetyflex spring technology. This technology allows every spring steel composition to absorb extreme amounts of energy from any types of impact. On any collision event the dynamics off our spring steel bollard can move around the five Cartesian coordinates, them

being x, y and z axis, and rotating on each axis. This allows it to behave as a torsion spring, a lateral translation spring and lateral bending spring, then returning to its original start point after impact allowing the shrouding. This allows the technology to retain its blocking purpose

All of these bespoke solution can be engineered to be crash certified for a 48-80kph range of speed camera

PLANT GIOVE

DESCRIPTION Manufactured from a mix of concrete & fine Italian marble aggregate, Protective planting solution providing 1, 224 litre planting capacity
Polished smooth surface treated with a

FINISH Protective varnish. The excavation depth should be at least 950mm

- ✓ Test1 - PAS68: 2010: V/7500(N2)/64/90:0.0/0.0
Crash tested to 7.5 tonne two axle rigid N2 lorry
Vehicle Speed: 40mph (64km/h)

- ✓ Test1 - PAS68: 2010: V/7500(N3)/80/90:1.7/0.0
7.5 tonne two axle rigid N3 lorry (empty 18 tonner)
Vehicle Speed: 50mph (80km/h)

- ✓ Test1 - PAS68: 2010: V/7500(N3)/80/90:3.8/35.5
Crash tested to 7.5 tonne two axle rigid N3 lorry (empty 18 tonner)
Vehicle Speed: 50mph (80km/h)

COLOURS White Granite Red Verona
Multi Veneziano
Yellow Mori
Black Ebony
Cream Bottoccino
Green Alps
Brown Porphyry

See page 14 for color swatches, materials and mounting options



SAFETY FLEX PLANTER

DESCRIPTION Stainless Steel planter box plugged to Springline Technology Bollard. The system is designed to be surface mounted with very shallow foundation - reducing the re-divert utilities requirements.

- ✓ PAS68 PLANTER (BSI PAS68:2010) V/7500(N2)/64/90:2.8/7.2
- ✓ Crash Tested to 7.50 tonnes at 40mph/64kph.
- ✓ Designed to be made to any size required



GRANITE PLANTERS

- ✓ Planter shroud over PAS68 rated Truckstopper Bollards
- ✓ Design flexibility
- ✓ Subtle high-quality security barriers

* See our Safetyflex Brochure for range of Truckstopper Bollards



IGNEO SEAT

DESCRIPTION Reinforced precast concrete strengthened by rhinoGuard technology/ Armrests Ferrocast polyurethane.

- ✓ Test1 - Centre: PAS68V/7500(N2)/64/90:3.7/0.0
- ✓ Test2 - Off Centre: V/7500(N2)/64/90:3.5/0.0
- ✓ Crash tested to 7.50 tonnes two axle rigid N2 lorry at 40mph/64kph.

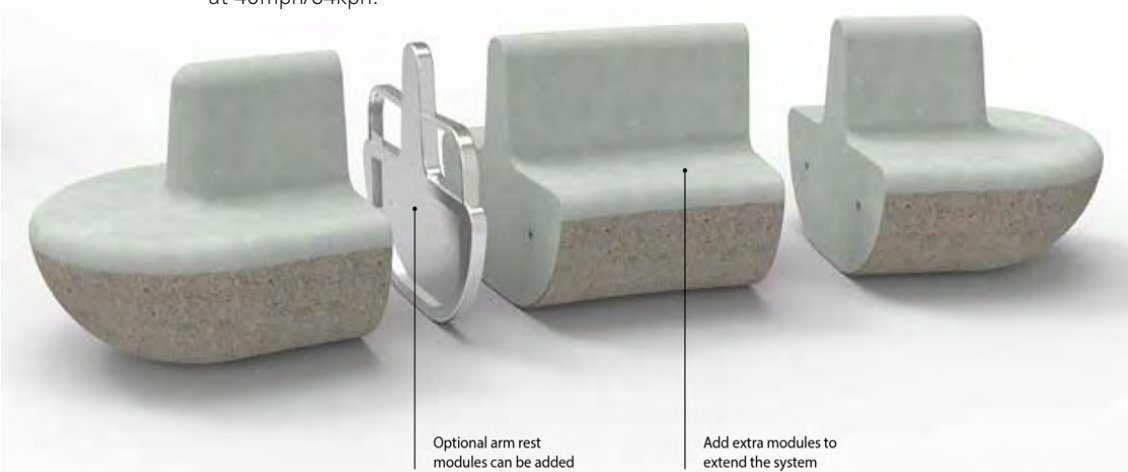

Igneo modular seating system can be specified to any length, based on the module sizes available

COLOUR & FINISH Pre-Cast Grey;
Pre-Cast White;
Pre-Cast Charcoal
Pre-Cast South Australian Black Ebony
See page 14 for color swatches, materials

DIMENSION & WEIGHT Centre Section Span - 1102mm
Left/Right Section Span - 1037mm
Seating Section - 474mm
Ferrocast Arm Section Weight - 21.5 Kg
Cast End Section Weight - 1000 Kg
Cast Intermediate Section Weight - 1200 Kg

EOS SEAT

DESCRIPTION With Ferrocast and Timber composition, this crash rated barrier combines form, function and strength - offering not just a great seating solution, but also security and resilience for the area. Excavation depth: 950mm

COLOUR Available in wide selection of RAL-colour system

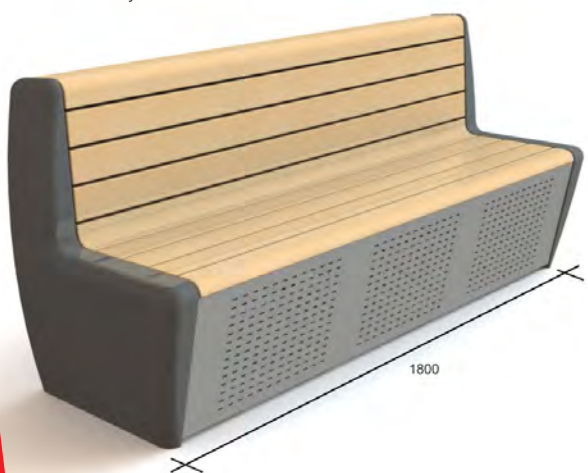

- ✓ Test 1: Front facing (centre): PAS68:2010:V/7500 (N2)/48/90:0.0/0.0
- ✓ Test 2: Back facing (centre): V/7500(N2)/48/90:3.1/0.0
- ✓ Test3: Back facing (Off centre): V /7500 (N2)/48/90:2.7/0.0
- ✓ Crash tested to 7.5 tonne two axle rigid N2 lorry travelling at 30mph (48km/h)

SAFETYFLEX CRASHBLOCK

NO requirements for a foundation
Can be modified to serve as a planter

- ✓ Test1: IWA 14-1:2013 Block V/7200[N2A]/48/90:4.1
- ✓ Test2: IWA 14-1:2013 Block V/7200[N2A]/64/90:6.7
- ✓ Crash tested to 7.5 tonne two axle rigid N2 lorry travelling at 30mph/64km/h

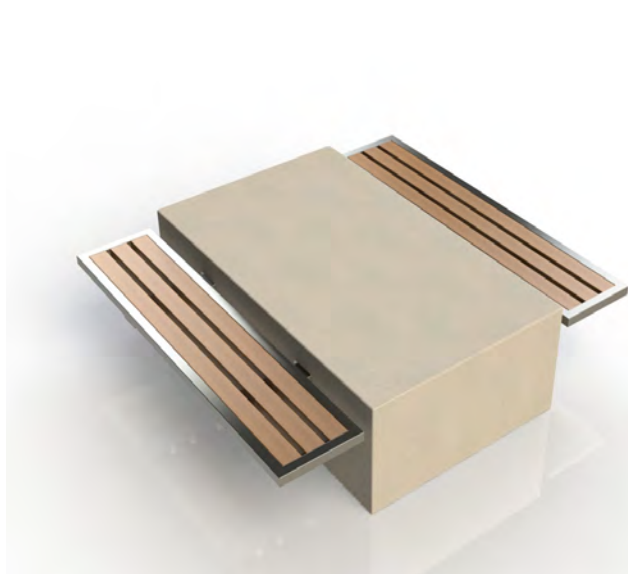

Ideal for permanent or temporary solutions and can be dressed in any cladding of choice

RHINOBLK SEAT

- ✓ Test1: IWA14-1:2013 BlokV/7200[N2A]/64/90:19.3
- ✓ Crash tested to 7.5 tonne two axle rigid N2A lorry travelling at 40mph (64km/h)

DESCRIPTION Protective concrete seat, available in a variety of finishes which integrate with the existing landscape, or alternatively, it can feature a timber-cladded top for a more modern look.

COLOUR & WEIGHT Available in Silver Grey, Mid Grey/Saxon Buff
2500 kg

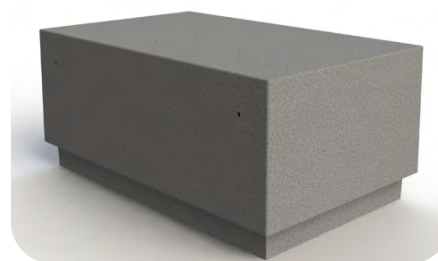

*Medium Grey

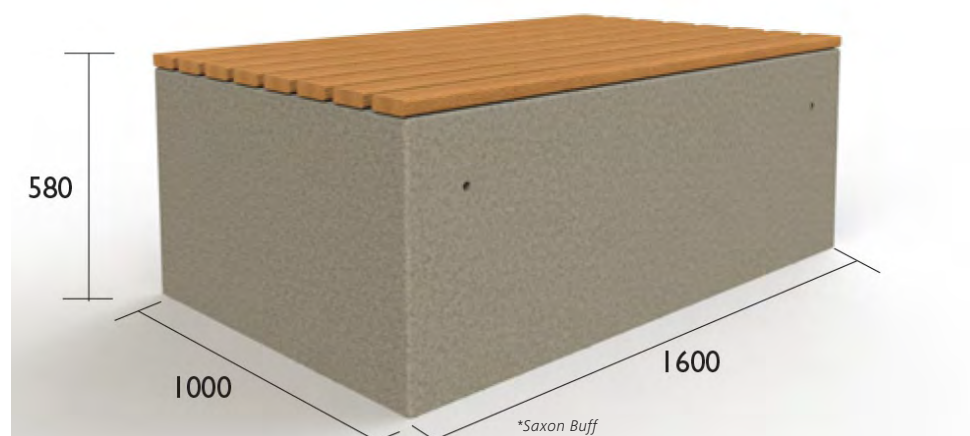

*Saxon Buff



*Silver Grey

RAPID DEPLOYABLE UNFIXED SOLUTIONS



IMPAKT DEFENDER

DESCRIPTION Manufactured from 100% recycled rubber and polyurethane, supplied complete with steel securing cables and fixings.

WEIGHT & DIMENSIONS WEIGHT: 430 kgs each
 DIMENSIONS: 1000 x 1004 x 1004 mm
 CONNECTIVITY: 20mm Ø Steel cables

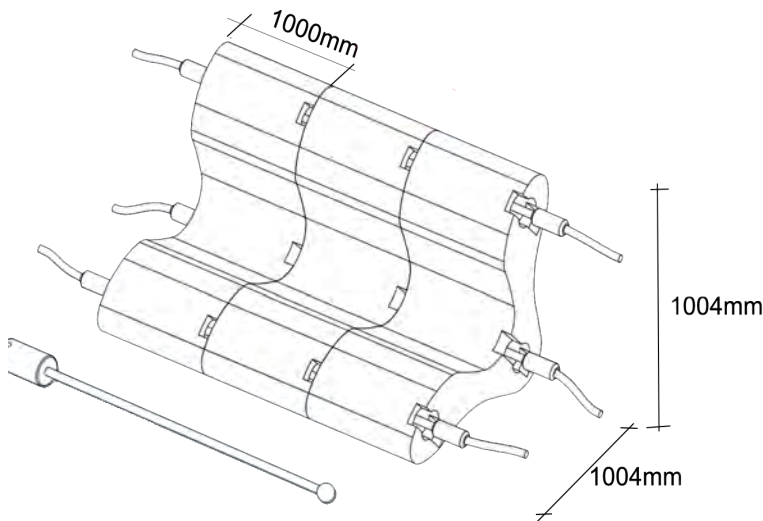

- ✓ Impact tested to IWA 14-1 specification
- ✓ Stopping a 7.2 tonne N2A lorry at 48kph (30mph).
- ✓ Vehicle security barrier (VSB)
- ✓ Requiring no foundations

RAPID DEFENDER

- ✓ Designed to provide protection for crowds of people at events from vehicle as a weapon (VAAW) attacks
- ✓ Temporary vehicle security barrier (VSB)
- ✓ Requiring no foundations and can be quickly deployed almost anywhere-
- ✓ Unbeatable lightweight



DESCRIPTION Manufactured from 100% recycled rubber and polyurethane, supplied complete with steel securing cables and fixings.

WEIGHT & DIMENSIONS WEIGHT: 49 kgs each
 DIMENSIONS: 333 x 600 x 600 mm
 CONNECTIVITY: 20mm Ø Steel cables

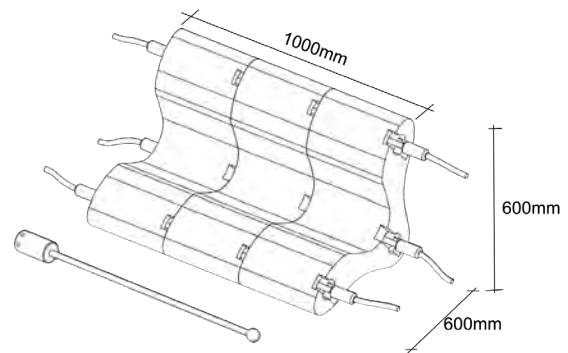







NSW (1)
11 Cooper St
Smithfield, NSW
Ph: 1300 558 304
E: sales@ezisecurity.com

QLD
Satellite Office
Ph: 1300 558 304
E: sales@ezisecurity.com

VIC / TAS
Satellite Office
Ph: 1300 558 304
E: sales@ezisecurity.com

NSW (2)
6/8 Cooper St
Smithfield NSW 2164
Ph: 1300 558 304

ACT
Satellite Office
Ph:1300 558 304
M: 0412 120 984
E: rod@ezisecurity.com

SA
Satellite Office
Ph: 1300 558 304
E: sales@ezisecurity.com

NZ
Satellite Office
M: + 61425311222

SINGAPORE
Satellite Office
Ph: +65 910 792 71

COMPANY CONTACT



11 Cooper St, Smithfield
New South Wales, Australia 2164



1300 558 304



info@ezisecurity.com

WWW.EZISECURITY.COM.AU



Ezi Security Systems
SERIOUS SECURITY TO EZI
CATALOGUE CONCEPT AND DESIGN:
EZI SECURITY SYSTEMS MARKETING
TONI LOTTE CHAN